

**Data sheet | Item number: 2001-1401**

4-conductor through terminal block; 1.5 mm<sup>2</sup>; suitable for Ex e II applications; side and center marking; for DIN-rail 35 x 15 and 35 x 7.5; Push-in CAGE CLAMP®

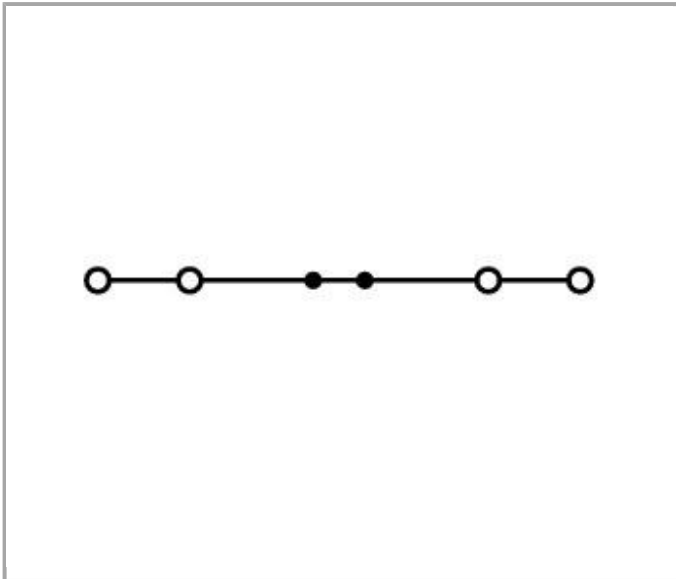

2001-1401

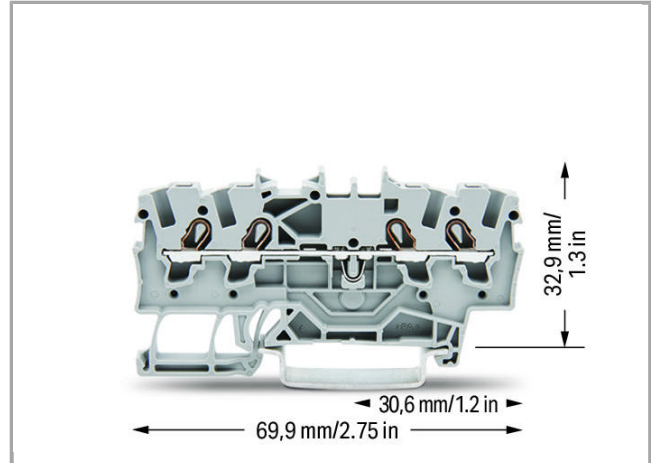

**Data**

**Electrical data**

Rated voltage EN (Ex e II)	550 V
Rated current (Ex e II)	17 A
Rated current (Ex e II) with jumper	16 A



### Ratings per IEC/EN 60664-1

Rated voltage (III / 3)	800 V
Rated impulse voltage (III / 3)	8 kV
Rated current	18 A
Rated current (2)	24 A

### Approvals per UL 1059

Rated voltage UL (Use Group B)	600 V
Rated current UL (Use Group B)	15 A
Rated voltage UL (Use Group C)	600 V
Rated current UL (Use Group C)	15 A

### Approvals per CSA

Rated voltage CSA (Use Group B)	600 V
Rated current CSA (Use Group B)	15 A
Rated voltage CSA (Use Group C)	600 V
Rated current CSA (Use Group C)	15 A

### Connection data

Connection technology	Push-in CAGE CLAMP®
Actuation type	Push-in Open Tool Slot
Connectable conductor materials	Copper
Nominal cross section	1.5 mm <sup>2</sup>
Solid conductor	0.25 ... 2.5 mm <sup>2</sup> / 22 ... 14 AWG
Solid conductor, push-in termination	0.75 ... 2.5 mm <sup>2</sup> / 18 ... 14 AWG
Fine-stranded conductor	0.25 ... 2.5 mm <sup>2</sup> / 22 ... 14 AWG
Strip length	9 ... 11 mm / 0.35 ... 0.43 inch
Note (conductor cross-section)	Depending on the conductor characteristic, a conductor with a smaller cross section can also be inserted via push-in termination.
Total number of connection points	4
Total number of potentials	1
Number of levels	1
Type of wiring	Front-entry wiring

### Geometrical Data

Width	4.2 mm / 0.165 inch
Height from upper-edge of DIN-35 rail	32.9 mm / 1.295 inch
Depth	69.9 mm / 2.752 inch

## Mechanical data

Design	horizontal
Type of mounting	DIN-35 rail
Marking level	Center/side marking

## Material Data



Color	gray
Insulating material	Polyamide 66 (PA 66)
Weight	5.86 g

## Commercial data

Product Group	22 (TOPJOB S)
Country of origin	DE
GTIN	4017332998666
Customs Tariff No.	85369010000

## Approvals / Certificates

### Ex-Approvals

Logo	Approval	Additional Approval Text	Certificate name
	AEx UL International Germany GmbH c/o Physikalisch Technische Bundesanstalt	UL 60079	E185892 sec.12
	ATEX Physikalisch Technische Bundesanstalt (PTB)	EN 60079	PTB 05 ATEX 1094 U (II 2 G Ex e II bzw. I M 2 Ex e I)
	IECEX Physikalisch Technische Bundesanstalt (PTB)	IEC 60079	IECEX PTB 11.0093U (Ex e IIC Gb or Ex e I Mb)

### Country specific Approvals

Logo	Approval	Additional Approval Text	Certificate name
	CCA DEKRA Certification B.V.	EN 60947	2160584.07
	CCA	EN 60947	NTR NL-



DEKRA Certification B.V.



7084

CSA  
DEKRA Certification B.V.

C22.2 No. 158

1645434

## Ship Approvals

Logo	Approval	Additional Approval Text	Certificate name
	<b>ABS</b> American Bureau of Shipping	EN 60947	14- HG1293677- PDA
	<b>DNV GL</b> Det Norske Veritas, Germanischer Lloyd	-	TAE00001V2
	<b>LR</b> Lloyds Register	EN 60947	91/20112 (E9)

## UL-Approvals



















Logo	Approval	Additional Approval Text	Certificate name
	<b>UL</b> UL International Germany GmbH	UL 1059	E45172



















## Compatible products

















## check















Item no.: 2001-511  
Modular TOPJOB®S connector; modular; for jumper contact slot; 1-pole

2001-511

















	<b>Item no.: 2001-549</b> Spacer module; modular; e.g., for bridging commoned terminal blocks	2001-549
	<b>Item no.: 2001-552</b> Modular TOPJOB®S connector; modular; for jumper contact slot; 2-pole	2001-552
	<b>Item no.: 2001-553</b> Modular TOPJOB®S connector; modular; for jumper contact slot; 3-pole	2001-553
	<b>Item no.: 2001-554</b> Modular TOPJOB®S connector; modular; for jumper contact slot; 4-pole	2001-554
	<b>Item no.: 2001-555</b> Modular TOPJOB®S connector; modular; for jumper contact slot; 5-pole	2001-555
	<b>Item no.: 2001-556</b> Modular TOPJOB®S connector; modular; for jumper contact slot; 6-pole	2001-556
	<b>Item no.: 2001-557</b> Modular TOPJOB®S connector; modular; for jumper contact slot; 7-pole	2001-557
	<b>Item no.: 2001-558</b> Modular TOPJOB®S connector; modular; for jumper contact slot; 8-pole	2001-558
	<b>Item no.: 2001-559</b> Modular TOPJOB®S connector; modular; for jumper contact slot; 9-pole	2001-559
	<b>Item no.: 2001-560</b> Modular TOPJOB®S connector; modular; for jumper contact slot; 10-pole	2001-560
	<b>Item no.: 2009-174</b> Test plug adapter; for 4 mm Ø test plugs; for testing TOPJOB®S rail-mounted terminal blocks	2009-174
	<b>Item no.: 2009-182</b> Testing tap; for max. 2.5 mm <sup>2</sup> ; tool-free connection for individual test wires 0.08 - 2.5 mm	2009-182
<b>Jumper</b>		
	<b>Item no.: 2001-402</b> Push-in type jumper bar; insulated; 2-way; Nominal current 18 A	2001-402
	<b>Item no.: 2001-403</b> Push-in type jumper bar; insulated; 3-way; Nominal current 18 A	2001-403
	<b>Item no.: 2001-404</b> Push-in type jumper bar; insulated; 4-way; Nominal current 18 A	2001-404
	<b>Item no.: 2001-405</b> Push-in type jumper bar; insulated; 5-way; Nominal current 18 A	2001-405
	<b>Item no.: 2001-405/011-000</b> Star point jumper; insulated; 3-way (1-3-5); IN = IN terminal block	2001-405 /011-000
	<b>Item no.: 2001-406</b> Push-in type jumper bar; insulated; 6-way; Nominal current 18 A	2001-406
	<b>Item no.: 2001-406/020-000</b> Delta jumper; insulated; 1-2 3-4 5-6; IN = IN terminal block	2001-406 /020-000

	<b>Item no.: 2001-407</b> Push-in type jumper bar; insulated; 7-way; Nominal current 18 A	2001-407
	<b>Item no.: 2001-408</b> Push-in type jumper bar; insulated; 8-way; Nominal current 18 A	2001-408
	<b>Item no.: 2001-409</b> Push-in type jumper bar; insulated; 9-way; Nominal current 18 A	2001-409
	<b>Item no.: 2001-410</b> Push-in type jumper bar; insulated; 10-way; Nominal current 18 A	2001-410
	<b>Item no.: 2001-433</b> Push-in type jumper bar; insulated; from 1 to 3; Nominal current 18 A	2001-433
	<b>Item no.: 2001-434</b> Push-in type jumper bar; insulated; from 1 to 4; Nominal current 18 A	2001-434
	<b>Item no.: 2001-435</b> Push-in type jumper bar; insulated; from 1 to 5; Nominal current 18 A	2001-435
	<b>Item no.: 2001-436</b> Push-in type jumper bar; insulated; from 1 to 6; Nominal current 18 A	2001-436
	<b>Item no.: 2001-437</b> Push-in type jumper bar; insulated; from 1 to 7; Nominal current 18 A	2001-437
	<b>Item no.: 2001-438</b> Push-in type jumper bar; insulated; from 1 to 8; Nominal current 18 A	2001-438
	<b>Item no.: 2001-439</b> Push-in type jumper bar; insulated; from 1 to 9; Nominal current 18 A	2001-439
	<b>Item no.: 2001-440</b> Push-in type jumper bar; insulated; from 1 to 10; Nominal current 18 A	2001-440
	<b>Item no.: 2006-499</b> Step-down jumper; insulated; from 6/4 mm <sup>2</sup> to 4/2.5/1.5 mm <sup>2</sup> ; Nominal current 32 A	2006-499
	<b>Item no.: 2009-412</b> Push-in type wire jumper; insulated; wire length 60 mm; Conductor cross section 1.5 mm <sup>2</sup> ; suitable for 2001, 2002, 2003 and 2022 Series rail-mounted terminal blocks	2009-412
	<b>Item no.: 2009-414</b> Push-in type wire jumper; insulated; wire length 110 mm; Conductor cross section 1.5 mm <sup>2</sup> ; suitable for 2001, 2002, 2003 and 2022 Series rail-mounted terminal blocks	2009-414
	<b>Item no.: 2009-416</b> Push-in type wire jumper; insulated; wire length 250 mm; Conductor cross section 1.5 mm <sup>2</sup> ; suitable for 2001, 2002, 2003 and 2022 Series rail-mounted terminal blocks	2009-416
	<b>Item no.: 210-103</b> Wire commoning chain; insulated; 50 connections	210-103
	<b>Item no.: 210-123</b> Wire commoning chain; insulated; 50 connections	210-123
<b>ferrule</b>		
	<b>Item no.: 216-241</b> Ferrule; Sleeve for 0.5 mm <sup>2</sup> / 20 AWG; insulated; electro-tin plated; electrolytic copper; gastight crimped; acc. to DIN 46228, Part 4/09.90	216-241

	<b>Item no.: 216-242</b> Ferrule; Sleeve for 0.75 mm <sup>2</sup> / 18 AWG; insulated; electro-tin plated; electrolytic copper; gastight crimped; acc. to DIN 46228, Part 4/09.90	216-242
	<b>Item no.: 216-243</b> Ferrule; Sleeve for 1 mm <sup>2</sup> / AWG 18; insulated; electro-tin plated; electrolytic copper; gastight crimped; acc. to DIN 46228, Part 4/09.90	216-243
	<b>Item no.: 216-244</b> Ferrule; Sleeve for 1.5 mm <sup>2</sup> / AWG 16; insulated; electro-tin plated; electrolytic copper; gastight crimped; acc. to DIN 46228, Part 4/09.90	216-244
<b>Insulation stop</b>		
	<b>Item no.: 2001-171</b> Insulation stop; 0.25 - 0.5 mm <sup>2</sup> ; 5 pieces/strip	2001-171
<b>Protective Warning Marker</b>		
	<b>Item no.: 2001-115</b> Protective warning marker; with high-voltage symbol, black; for 5 terminal blocks	2001-115
<b>End plate</b>		
	<b>Item no.: 2002-1491</b> End and intermediate plate; 0.8 mm thick	2002-1491
	<b>Item no.: 2002-1492</b> End and intermediate plate; 0.8 mm thick	2002-1492
	<b>Item no.: 2002-1493</b> Separator plate; 2 mm thick; oversized	2002-1493
	<b>Item no.: 2002-1494</b> Separator plate; 2 mm thick; oversized	2002-1494
	<b>Item no.: 209-191</b> Separator for Ex e/Ex i applications; 3 mm thick; 120 mm wide	209-191
<b>Marking accessories</b>		
	<b>Item no.: 2009-110</b> Marking strips; on reel; not stretchable; plain; snap-on type	2009-110
	<b>Item no.: 2009-114</b> WMB-Inline; for Smart Printer; on reel; stretchable 4 - 4.2 mm; plain; snap-on type	2009-114
	<b>Item no.: 2009-114/000-002</b> WMB-Inline; for Smart Printer; on reel; stretchable 4 - 4.2 mm; plain; snap-on type	2009-114 /UUU-UU2
	<b>Item no.: 2009-114/000-005</b> WMB-Inline; for Smart Printer; on reel; stretchable 4 - 4.2 mm; plain; snap-on type	2009-114 /UUU-UU5
	<b>Item no.: 2009-114/000-006</b> WMB-Inline; for Smart Printer; on reel; stretchable 4 - 4.2 mm; plain; snap-on type	2009-114 /UUU-UU6
	<b>Item no.: 2009-114/000-007</b> WMB-Inline; for Smart Printer; on reel; stretchable 4 - 4.2 mm; plain; snap-on type	2009-114 /UUU-UU7

	<b>Item no.: 2009-114/000-012</b> WMB-Inline; for Smart Printer; on reel; stretchable 4 - 4.2 mm; plain; snap-on type	/000-012	2009-114
	<b>Item no.: 2009-114/000-023</b> WMB-Inline; for Smart Printer; on reel; stretchable 4 - 4.2 mm; plain; snap-on type	/000-023	2009-114
	<b>Item no.: 2009-114/000-024</b> WMB-Inline; for Smart Printer; on reel; stretchable 4 - 4.2 mm; plain; snap-on type	/000-024	2009-114
	<b>Item no.: 793-4501</b> WMB marking card; as card; stretchable 4 - 4.2 mm; plain; snap-on type		793-4501
	<b>Item no.: 793-4501/000-002</b> WMB marking card; as card; stretchable 4 - 4.2 mm; plain; snap-on type	/000-002	793-4501
	<b>Item no.: 793-4501/000-005</b> WMB marking card; as card; stretchable 4 - 4.2 mm; plain; snap-on type	/000-005	793-4501
	<b>Item no.: 793-4501/000-006</b> WMB marking card; as card; stretchable 4 - 4.2 mm; plain; snap-on type	/000-006	793-4501
	<b>Item no.: 793-4501/000-007</b> WMB marking card; as card; stretchable 4 - 4.2 mm; plain; snap-on type	/000-007	793-4501
	<b>Item no.: 793-4501/000-012</b> WMB marking card; as card; stretchable 4 - 4.2 mm; plain; snap-on type	/000-012	793-4501
	<b>Item no.: 793-4501/000-017</b> WMB marking card; as card; stretchable 4 - 4.2 mm; plain; snap-on type	/000-017	793-4501
	<b>Item no.: 793-4501/000-023</b> WMB marking card; as card; stretchable 4 - 4.2 mm; plain; snap-on type	/000-023	793-4501
	<b>Item no.: 793-4501/000-024</b> WMB marking card; as card; stretchable 4 - 4.2 mm; plain; snap-on type	/000-024	793-4501
	<b>Item no.: 793-501</b> WMB marking card; as card; not stretchable; plain; snap-on type		793-501
	<b>Item no.: 793-501/000-002</b> WMB marking card; as card; not stretchable; plain; snap-on type	/000-002	793-501
	<b>Item no.: 793-501/000-005</b> WMB marking card; as card; not stretchable; plain; snap-on type	/000-005	793-501



	<b>Item no.: 793-501/000-006</b> WMB marking card; as card; not stretchable; plain; snap-on type	793-501 /000-006
	<b>Item no.: 793-501/000-007</b> WMB marking card; as card; not stretchable; plain; snap-on type	793-501 /000-007
	<b>Item no.: 793-501/000-012</b> WMB marking card; as card; not stretchable; plain; snap-on type	793-501 /000-012
	<b>Item no.: 793-501/000-017</b> WMB marking card; as card; not stretchable; plain; snap-on type	793-501 /000-017
	<b>Item no.: 793-501/000-023</b> WMB marking card; as card; not stretchable; plain; snap-on type	793-501 /000-023
	<b>Item no.: 793-501/000-024</b> WMB marking card; as card; not stretchable; plain; snap-on type	793-501 /000-024
<b>Carrier rail</b>		
	<b>Item no.: 210-112</b> Steel carrier rail; 35 x 7.5 mm; 1 mm thick; 2 m long; slotted; according to EN 60715; "Hole width 25 mm	210-112
	<b>Item no.: 210-113</b> Steel carrier rail; 35 x 7.5 mm; 1 mm thick; 2 m long; unslotted; according to EN 60715	210-113
	<b>Item no.: 210-114</b> Steel carrier rail; 35 x 15 mm; 1.5 mm thick; 2 m long; unslotted; similar to EN 60715	210-114
	<b>Item no.: 210-115</b> Steel carrier rail; 35 x 7.5 mm; 1 mm thick; 2 m long; slotted; according to EN 60715; "Hole width 18 mm	210-115
	<b>Item no.: 210-118</b> Steel carrier rail; 35 x 15 mm; 2.3 mm thick; 2 m long; unslotted; according to EN 60715	210-118
	<b>Item no.: 210-196</b> Aluminum carrier rail; 35 x 8.2 mm; 1.6 mm thick; 2 m long; unslotted; similar to EN 60715	210-196
	<b>Item no.: 210-197</b> Steel carrier rail; 35 x 15 mm; 1.5 mm thick; 2 m long; slotted; similar to EN 60715	210-197
	<b>Item no.: 210-198</b> Copper carrier rail; 35 x 15 mm; 2.3 mm thick; 2 m long; unslotted; according to EN 60715	210-198
<b>tools</b>		
	<b>Item no.: 210-647</b> Operating tool with partially insulated shaft; Blade (2.5 x 0.4) mm; short	210-647
	<b>Item no.: 210-648</b> Operating tool with partially insulated shaft; Blade (2.5 x 0.4) mm; short; angled	210-648



Item no.: 210-719

210-719

Operating tool with partially insulated shaft; Type 1, blade (2.5 x 0.4) mm

---

### Downloads

#### Documentation

#### Bid Text

2001-1401	Apr 4, 2012	docx 15.1 kB	Download
Reihenklemmen, TOPJOB S			

---

#### Additional Information

pdf 2.1 MB	Download
---------------	----------

---

### CAD/CAE - Smart Data

#### CAD data

3D Download 2001-1401	URL	Download
-----------------------	-----	----------

---

Subject to changes.

---